

# IDEAL VT130SP

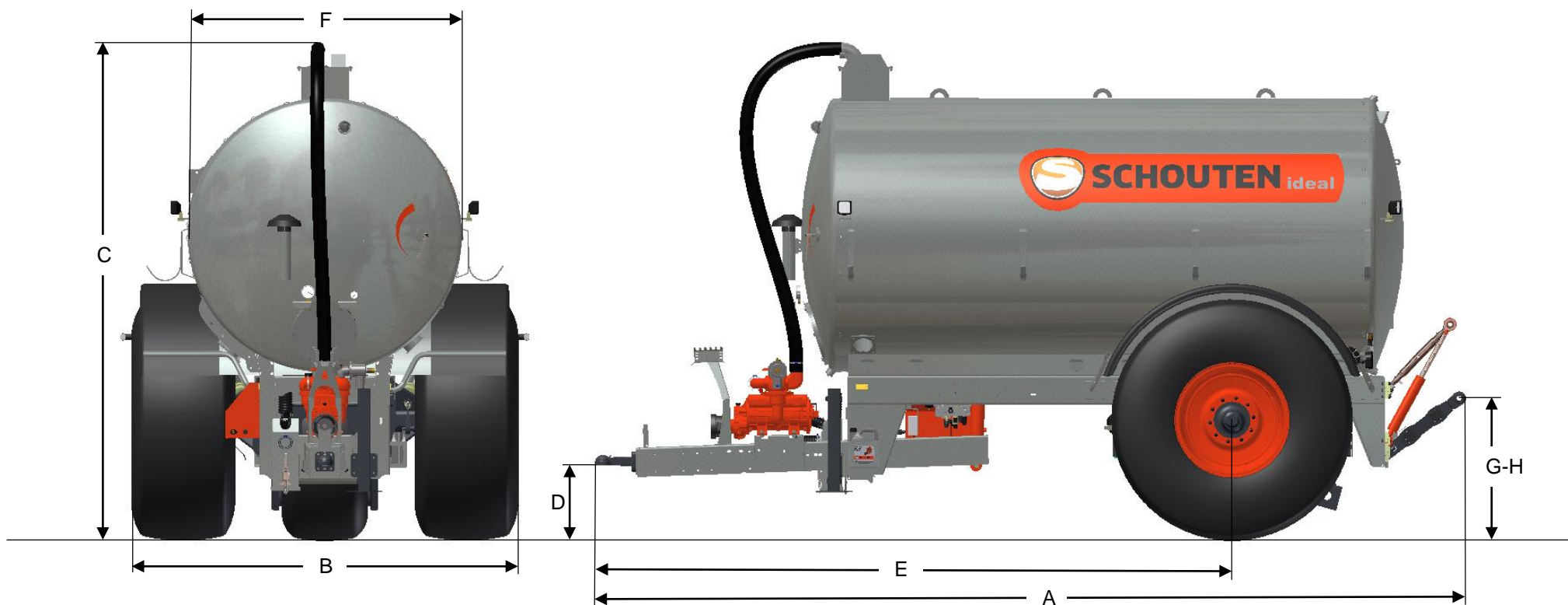

## AFMETINGEN

A	LENGTE	6612 MM	E	AFSTAND TREKOOG – WIELAS	4818 MM
B	BREEDTE	2870 MM	F	TANKDIAMETER	2100 MM
C	HOOGTE	3825 MM	G	HOOGTE HEF MIN.	235 MM
D	AANSPANHOOGTE	400-700 MM	H	HOOGTE HEF MAX.	990 MM

# IDEAL VT130SP

## MACHINE INFORMATIE

TYPE	VT130SP
GEWICHT	5300 KG
TANKAFMETING	Ø2100X4040 MM
TANKINHOUD	13.000 LTR
NIVEAU AANDUIDING	VLOTTERWIJZER
ONDERSTEL	DRIEWIELONDERSTEL
TYPE ONDERSTEL	BPW GEREMD □150MM
DRAAGVERMOGEN ONDERSTEL	15.000 KG
BANDEN	800/60R32 – 650/55R26.5

STEUNPOOT	HYDR. DW
VACUUMPOMP	B&P MEC11000
CAPACITEIT VACUUMPOMP	11.137 L/MIN
AANDRIJVING VACUUMPOMP	PTO 540/1000RPM
VOCHTVANGER CAPACITEIT	15.500 L/MIN
HEFMOGELIJKHEDEN	GRAS – BOUWLAND
HEFCAPACITEIT	3500 KG
AANSPANNING HEFINRICHTING	4-PUNTS CAT III

## OPTIES

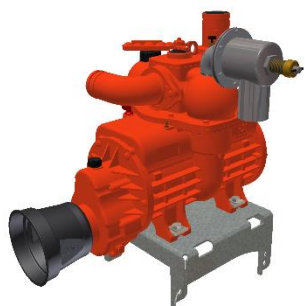

B&P MEC13500

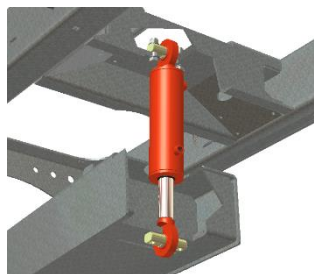

GEVEERDE DISSEL



TURBO-MASTER 8-6



ZUIGARM 8" BOLKOP



ZUIGARM 10" TURBO